

CHAPTER 10 - CEREMONIAL PARADE - REVIEW OF WG

REVIEW OF A WG

1. Sqn WO's march on their Sqns independently consisting only of cadets and NCOs.
2. Flt Cdr's and supernumerary officers perambulate until Sqn are on parade, then they halt and turn inwards towards parade.
3. Once all Sqns are dressed off and the Wg WO is satisfied, the Wg WO will then prove the Wg

Wing - **stand at** - EASE
Shun

and tell the Sqn WO's to take post. They will move to their positions at the rear of the First File of 3 of each No 1 Flt, level with NCOs.

4. The Wg WO will then give

Wing - **stand at** - EASE

5. The Wg WO about turns and stands at ease, and await the Wg Adjt to march on. The Wg WO will then give

Wing - **Shun**

salute the Wg Adjt and say

The Wing is ready sir/ma'm

6. The Wg Adjt will tell the Wg WO to take post. The Wg WO will again salute and move to first position which is 10 paces past the right hand marker, halt and about turn to face parade.
7. The Wg Adjt will now prove the Wg

Wing - **stand at** - EASE
Wing - **Shun**

8. The Wg Adjt then moves to the left and gives the command

Fall in the officers

9. At this stage the officers salute up, two, three, down. The Wg Adjt returns the salute. They pause, turn left then march to their positions. At the same time the Sqn Cdrs move to their positions (which is 6 paces front and centre of their respective Sqns and 12 paces front and centre if the Banner is to be marched on).

10. The Sqn Cdrs, once their officers have fallen in, will independently in sequence prove their Sqns.

No 1 Squadron - No 2 Squadron - No 3 Squadron

stand at - EASE

Shun

11. Then about turn to face dais.

12. The Wg Adjt will then say

Tell off by Squadrons

and the Sqn Cdrs will answer

No 1 Squadron - No 2 - No 3 Squadron

13. The Wg Adjt will then say

Nos 1 and 3 Squadrons - **stand at** - EASE

No 2 Squadron - **stand at** - EASE

14. Then about turn and await the Wg Cdr.

15. Wg Adjt will then say

Wing - **Shun**

and salute and say

Wing ready sir/ma'm

16. The Wg Cdr will then say

Take post

17. The Wg Adjt will salute and return to a position which is level with the Sqn Cdrs and 3 paces in front of No 1 Sqn Adjt position and turn into line.

18. The Wg Cdr will prove the Wg

Wing - **stand at** - EASE

Wing - **Shun**

Wing - **open order** - MARCH

right - DRESS

19. At which point the Wg WO will move to the most suitable position to check the dressing of each Sqn.

20. The Wg WO will then move to his new position which is 4 paces behind the First File of 3s of No 1 Flt of No 1 Sqn and say

Wing steady

21. At which point the Wg Cdr will say

eyes - FRONT

22. The Wg Cdr will give

Officers will take post in review order - **outwards** - TURN

23. At which point the supernumerary officers at the rear will turn left and the Wg Adjts, Sqn Adjts and Flt Cdrs will turn right.

Note: The Sqn Cdrs are to Stand Fast at this time.

24. The Wg Cdr will then give

Officers - **quick** - MARCH

25. The supernumerary officers will move round the left flanks of their Flts to take up equal distance 3 paces in front in review order. At the same time, the Flt Cdrs and Sqn Adjts will move along another 3 paces to make room for the supernumerary officers. At the same time, the Wg Adjts will also move 3 paces so he is level with the Sqn Adjts. Once they are all in position the Wg Cdr will give

Officers - **inwards** - TURN

so they are all facing the dais. At this point the Wg Cdr will give

Wing - **stand at** - EASE

26. About turn and await the Reviewing Officer. Reviewing Officer arrives, Wg Cdr gives

Parade – **Shun**

27. Once the Reviewing Officer is on the dais

Parade - **general** - SALUTE

28. All officers in review salute. Up, two, three, four, five, down. Wg Cdr marches forward to dais, salutes and reports

Parade ready for your inspection sir/ma'm

39. At which point the Flt Cdrs and Adjts about turn.

eyes - FRONT

40. At which point the Execs about turn again, the Wg Cdr then gives the command

Parade will march past in column of route - No 1 Squadron leading

41. At this juncture, the band will move to a position where it can lead the parade past the Reviewing Officer.

42. At the same time, each Sqn Cdr will independently give the command

No 1, No 2 and No 3 Squadron move to the right in column of route - **right - TURN**

43. At this point, the Wg Cdr is to take up his position at the head of No 1 Flt of No 1 Sqn. The Flt Cdr of No 1 Flt of No 1 Sqn will then give the order

No 1 Flight by the left - **quick - MARCH**

44. If a band is on parade, liaise with Band Master for positioning, this will depend on weather and size of parade ground, eg refer to diagrams of March Past.

45. Followed by Nos 2 and 3 Flts. All other Sqns following suit. Before approaching point 'A' marker, each Flt Cdr will give the command

No Flight by the right - **eyes - RIGHT**

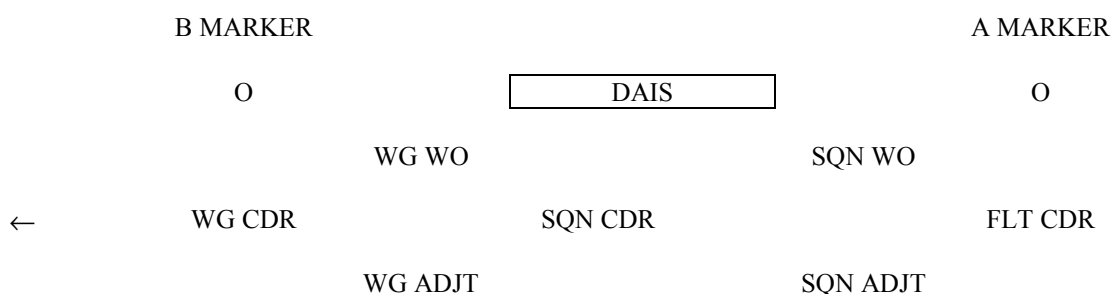

46. All the above salute on the March Past as do Sqn Execs. The ones that do not are the supernumerary officers at the rear of their Flts.

47. As each Flt individually passes the point 'B' marker and the last member of the Flt is level with the marker, usually the supernumerary officers, individual Flt Cdrs will give

No Flight - **eyes - FRONT**

48. At this point, all the parade is marched off to a suitable dispersal area either under the Wg Cdr or individual Sqn Cdrs.

Annexes:

- A. Diagram of Wg when Marched on by WOs.
- B. Wg in Line of Sqns in Close Column of Flts.
- C. Diagram of Wg with Officers in Review Order Positions.
- D. Diagram of Wg Turned Right in Column of Route Ready to March Past.
- E. Diagram Showing the March Past.
- F. Wg in Column of Route (in Close Column of Sqns).
- G. Key to Diagrams.

DIAGRAM OF WG WHEN MARCHED ON BY WOS

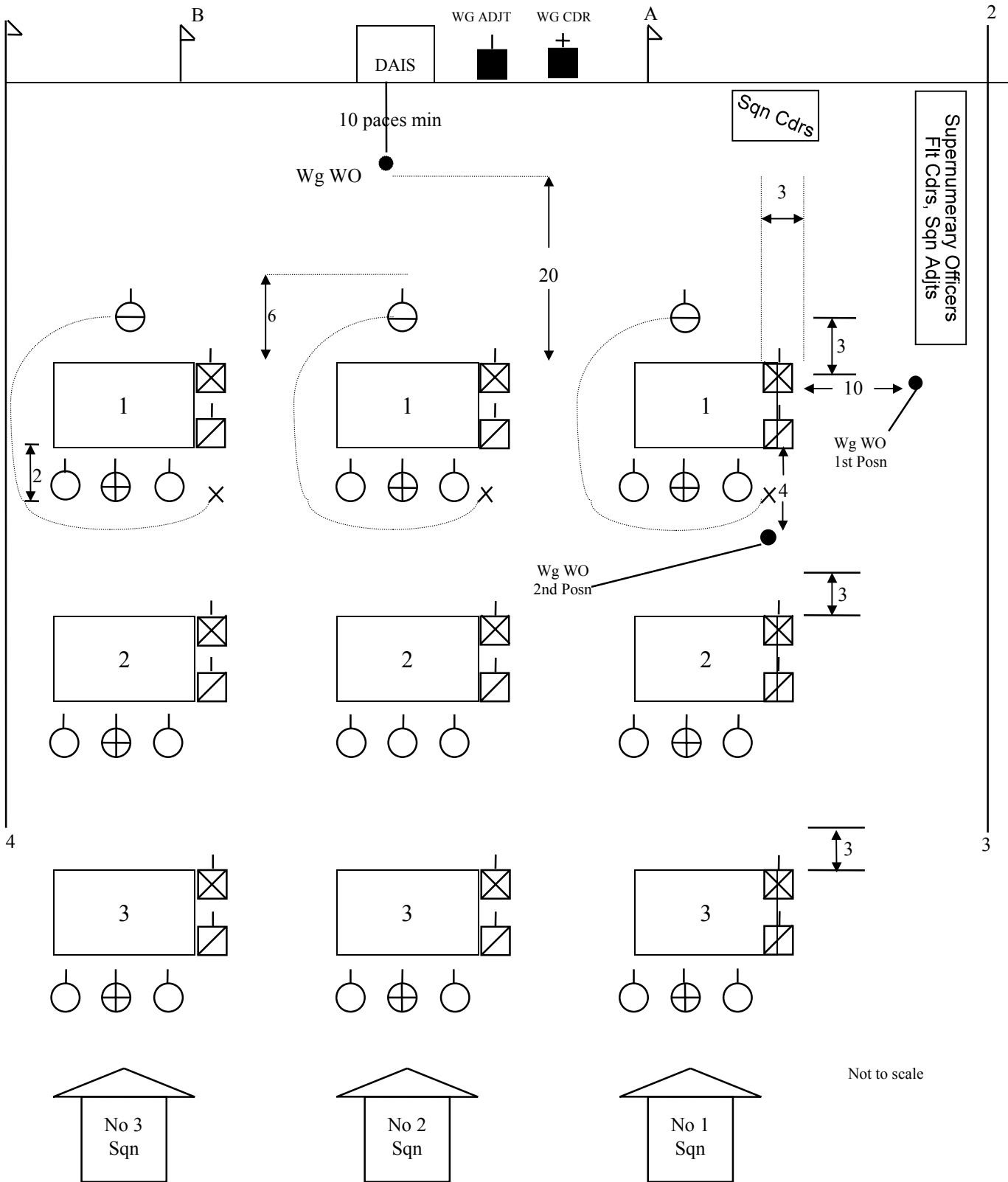

INTENTIONALLY

BLANK

INTENTIONALLY

BLANK

INTENTIONALLY

BLANK

DIAGRAM OF WG TURNED RIGHT IN COLUMN OF ROUTE READY TO MARCH PAST

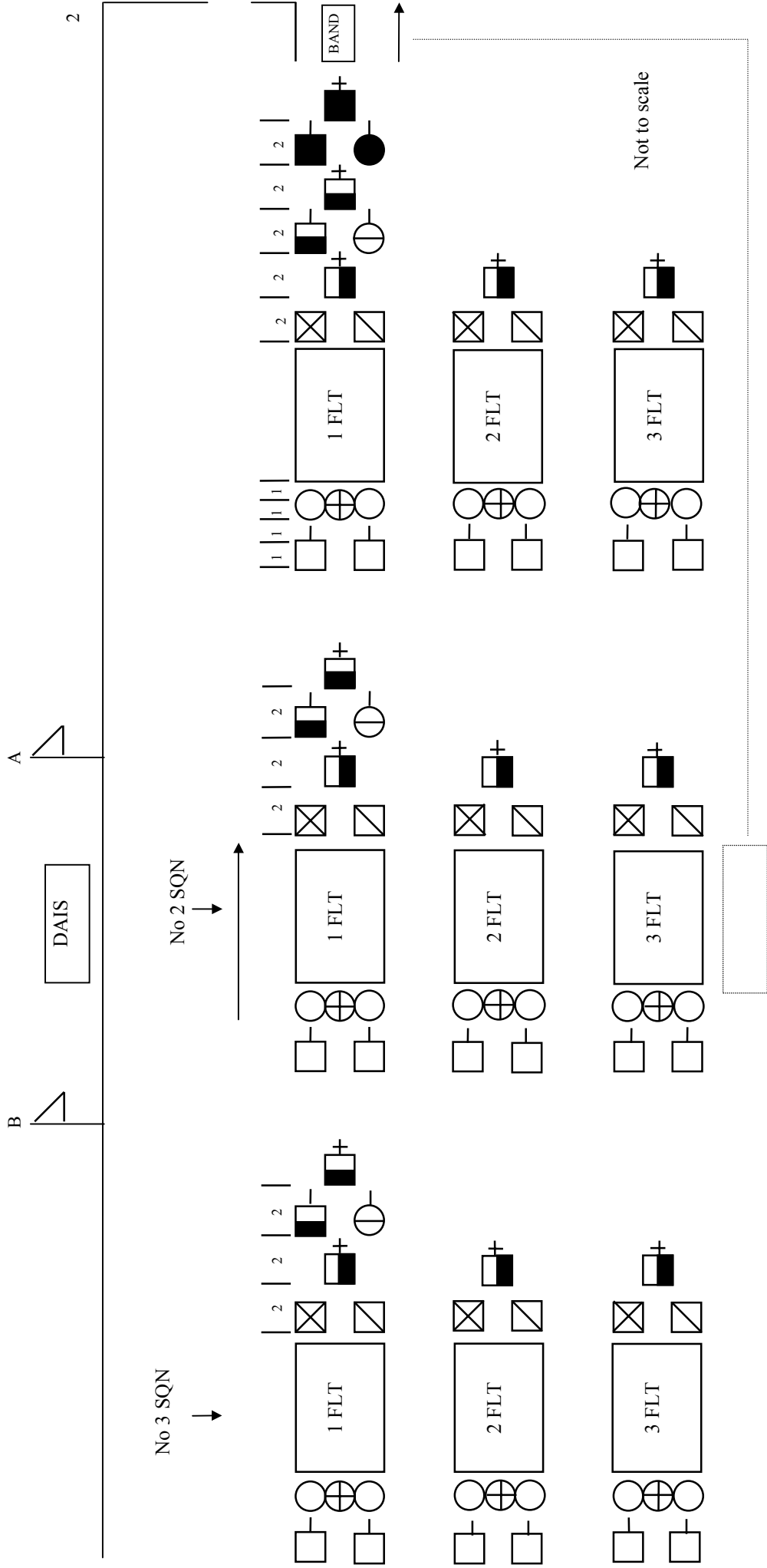

INTENTIONALLY

BLANK

DIAGRAM SHOWING THE MARCH PAST

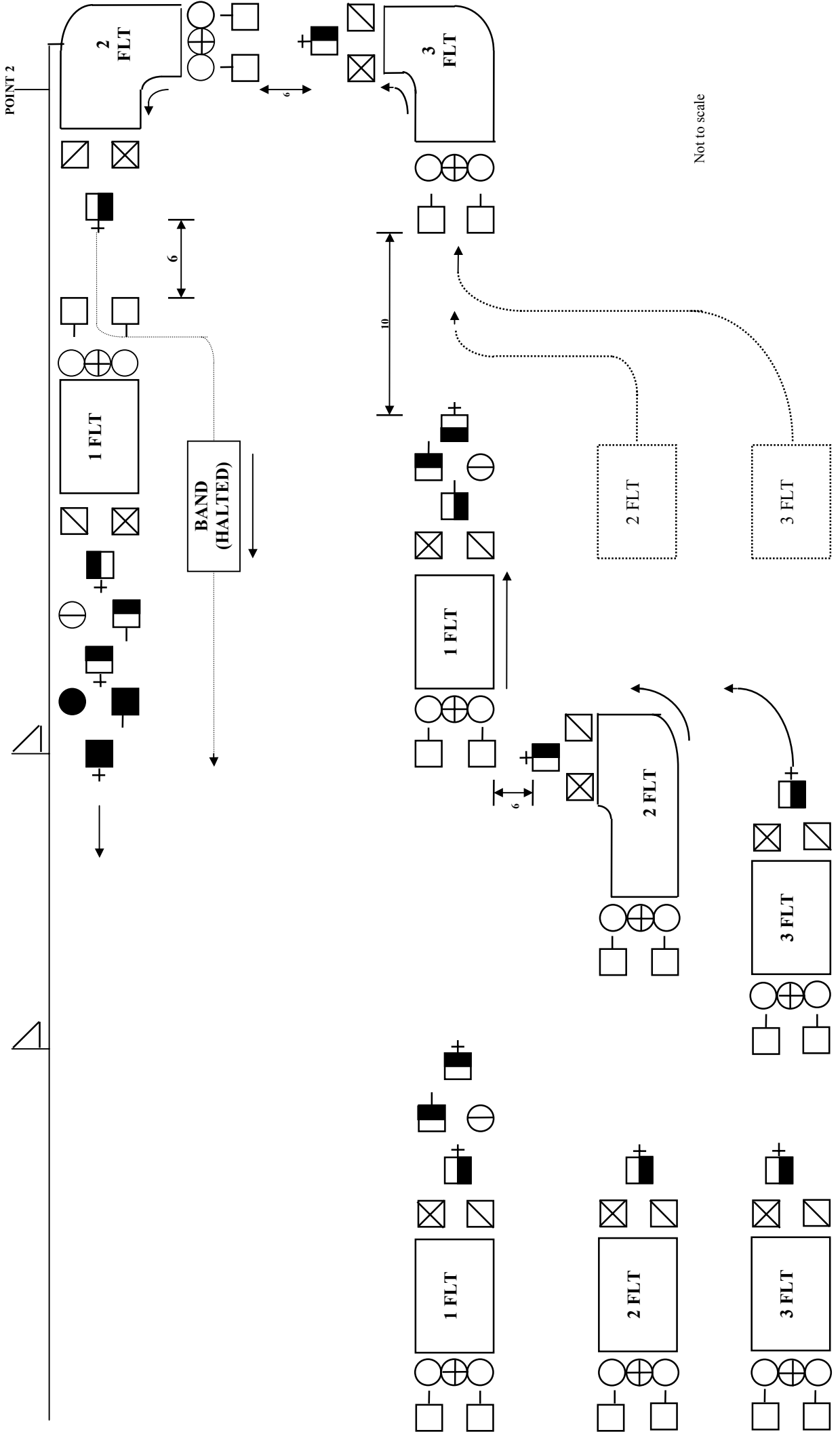

INTENTIONALLY

BLANK

WG IN COLUMN OF ROUTE (IN CLOSE COLUMN OF SQNS)

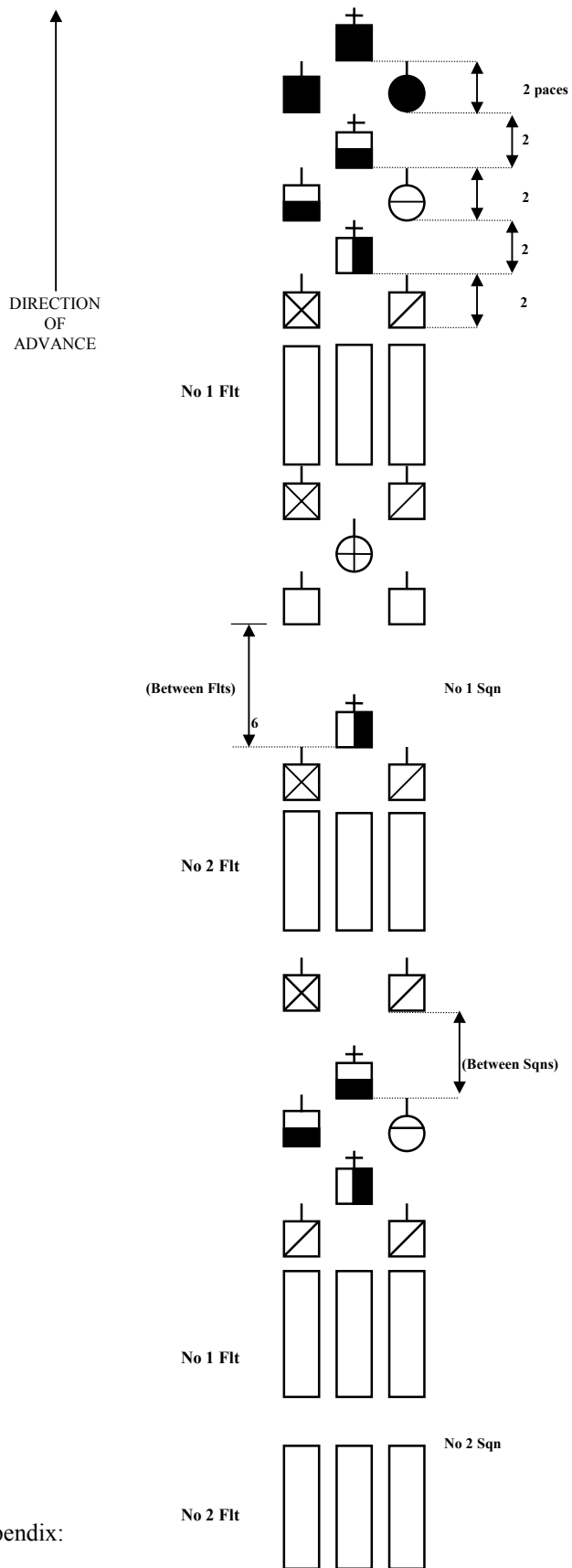

Note: Only sufficient of the appointments are shown to display the pattern of layout. Other officers and airmen are to be positioned accordingly.

Not to scale

Appendix:

1. Wg in Column of Route - Positions of Executives and Supernumeraries.

INTENTIONALLY

BLANK









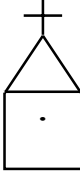

WG IN COLUMN OF ROUTE - POSITIONS OF EXECS AND SUPERNUMERARIES

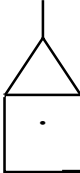
Appointment (a)	Position (b)
1. Wg Cdr	Ten paces centrally in front of the leading marker and guide.
2. Wg Adjt	Two paces to the rear and one pace to the left of the Wg Cdr (directly in front of the Sqn Adjt).
3. Wg WO	Two paces to the rear and one pace to the right of the Wg Cdr (directly in front of the Sqn WO).

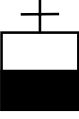
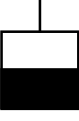
INTENTIONALLY

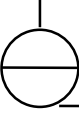
BLANK

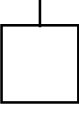
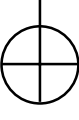
KEY TO DIAGRAMS

	WING PARADE COMMANDER	Wg Parade Cdr		BANDMASTER
	WING ADJUTANT	Wg Adj		DRUM MAJOR
	WING WARRANT OFFICER	Wg WO		
	SQUADRON COMMANDER	Sqn Cdr		
	SQUADRON ADJUTANT	Sqn Adj		GUIDE
	SQUADRON WARRANT OFFICER	Sqn WO		MARKER
	FLIGHT COMMANDER	Flt Cdr		
	SUPERNUMERARY OFFICER			
	NCO IC FLIGHT	NCO IC Flt		
	SUPERNUMERARY NCO			

INTENTIONALLY

BLANK